

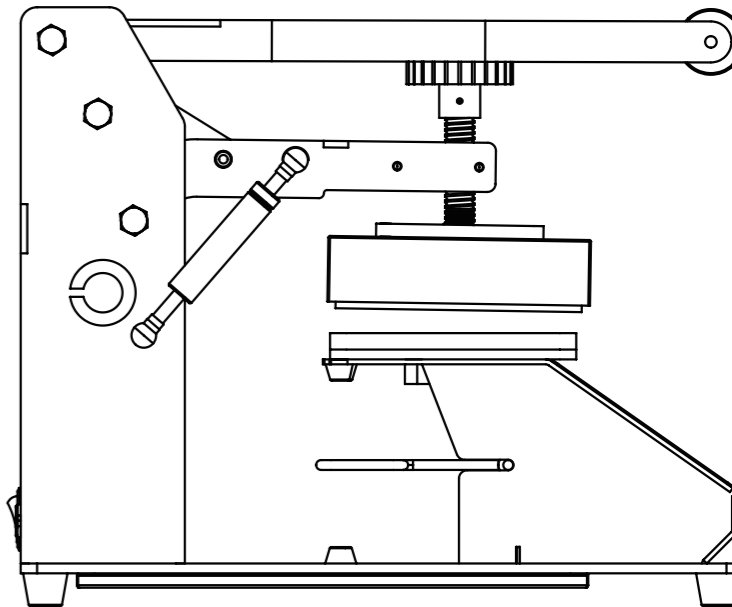

COMBO HEAT PRESS 3 IN 1

The user manual is universal for all heater combo versions and is suitable for all colors of machines.

USER MANUAL



COMBO HEAT PRESS

- 1 Pressure Knob
- 2 Pressure Handle
- 3 Silicone Pad
- 4 Digital Control Meter
- 5 Heating Platen
- 6 Power Switch
- 7 Hat Stretcher



Power	550W MAX±5%
Voltage	220V / 110V 50-60Hz
Temp. Range	0-482 °F (32-250°C)
Time Range	0-999 seconds

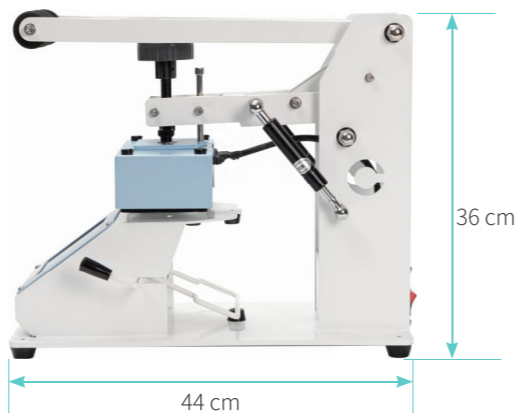

COMBO



Heat Press

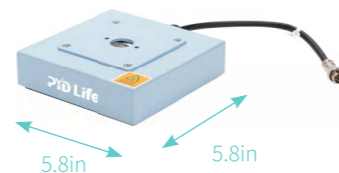

Pen Press

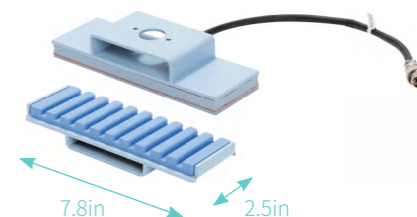

Cap Press

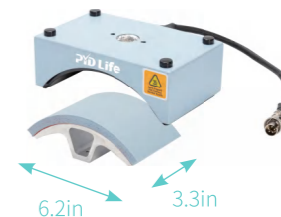

KNOW THE CONTROL PANEL

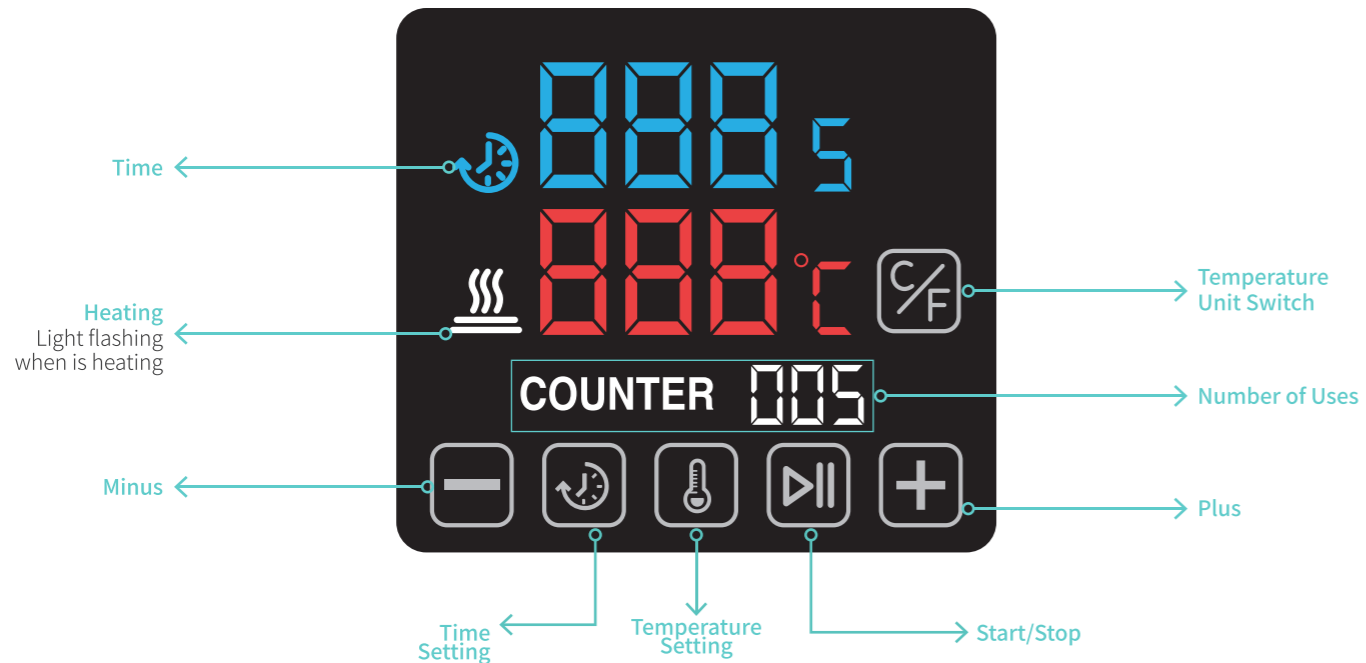

HOW TO USE THE CONTROL PANEL?

1. How to switch between °F and °C ?



Click the button to switch between °C and °F

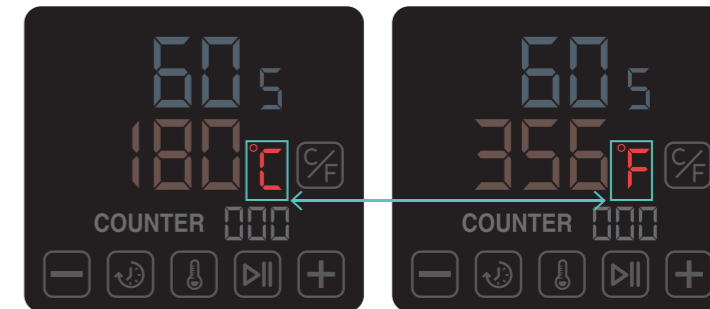

2. How to clear the number of uses?



Long press the Time button for 8 seconds to clear the number of uses

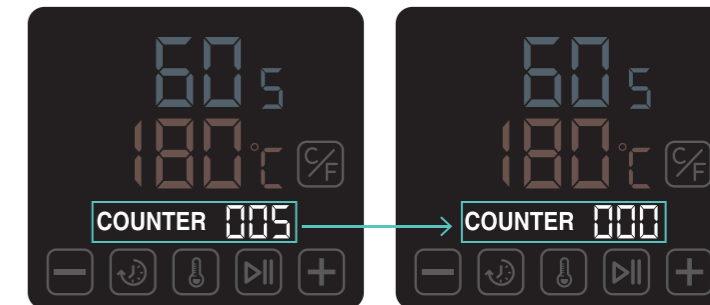

3. How to set the time?



1. Click the Time button to enter time setting mode;



2. Click the Plus or Minus button to adjust the value;



3. Click the Time button again, exit time setting mode.



4. How to set the temperature?



1. Click the Temperature button to enter temperature setting mode;



2. Click the Plus or Minus button to adjust the value;



3. Click the Temperature button again, exit temperature setting mode.



5. Start printing

1. Click the Start button to start the countdown;
2. Press down the handle also can start the countdown automatically;
3. Click the Start button again at any time to stop the countdown.



6. Temperature compensation

If the actual temperature of the heater does not match the value displayed on the screen, the temperature compensation value needs to be adjusted.

Enter the exact temperature difference value to be made up. For example, if the actual temperature is 190°C while the value displayed is 180°C, then enter 10 as temperature difference value.



1. Long press the Start button for 8 seconds to enter the temperature compensation settings;



2. Click the Plus or Minus button to adjust the value;



3. Long press the Start button for 8 seconds again to exit the temperature compensation settings.

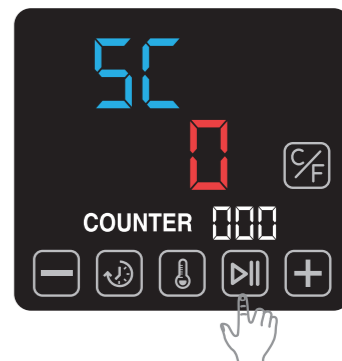

7. Restore default values

After pressing the Start button for 8 seconds to enter the temperature compensation settings, click the Start button to switch to the settings page for the other 3 values, which we normally do not need to change. If you have accidentally changed the values, you can adjust them back to the default values according to the diagram below.



1. Long press the Start button for 8 seconds to enter the temperature compensation settings;



2. Click the Start button to switch the screen;



3. Click the Plus or Minus button to adjust the value;



4. Long press the Start button for 8 seconds again to exit the temperature compensation settings.

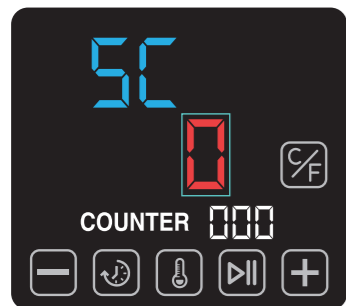

The default temp. difference value is 0;



The default power parameter is 16;



The default current parameter is 100;

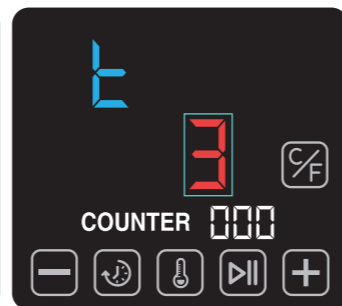

The default time interval is 3.

HOW TO PRINT A BAG?



- 1 Fix the image on the bag with heat-resistant tape;



- 2 Put a piece of protective paper on the silicon pad so that the inks won't ruin the silicon pad and the printed items;



- 3 Put the item on the protective paper and cover the item with another piece of protective paper;



- 4 Adjust the printing pressure;



- 5 Turn on the machine; set printing time and temperature, and wait for the machine to heat up;



- 6 When the machine heats up to the set temperature, press down the handle, and the machine will start the countdown automatically;



- 7 After the countdown, the machine will beep a sound and then lift up the handle;



- 8 Remove the image as it cools down; check the amazing printout result.

HOW TO INSTALL THE CAP HEATER?



1 Turn off the machine;



2 Remove the heating platen;



3 Secure the bottom with screws;



4 Secure the cap heater with screws;



5 Plug in the connect cable, and the installation is complete!

HOW TO PRINT A CAP?



1 Fix the image on the cap with heat-resistant tape;



2 Place the cap on the pad and secure the cap with the holding device;



3 Adjust the printing pressure;



4 Turn on the machine;



5 Set the printing time and temperature;



6 As the machine heats up to the set temperature, press down the handle, and the machine will start the countdown automatically;



7 After the countdown, lift up the handle;



8 Check the amazing printout result!

HOW TO INSTALL THE PEN HEATER?



1 Turn off the machine;



2 Remove the heating platen;



3 Secure the bottom with screws;



4 Secure the pen heater with screws;

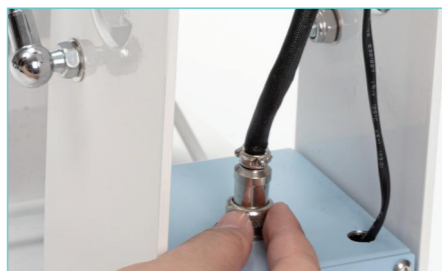

5 Plug in the connect cable, and the installation is complete!

HOW TO PRINT A PEN?



1 Fix the image on the pen with heat-resistant tape;



2 Put the pen on the machine, lined up neatly with the print side facing up;



3 Adjust the printing pressure;



4 Turn on the machine;



5 Set the printing time and temperature;



6 As the machine heats up to the set temperature, press down the handle, and the machine will start the countdown automatically;







7 After the countdown, lift up the handle;



8 Check the amazing printout result!

PRINTING PARAMETERS

Product						
Product Name	DTF	HTV	Leather Patches	Sublimation Paper	T-shirt	Bag
Temperature	320 °F	320 °F	356 °F	356 °F	374 °F	374 °F
Time	15 s	15 s	50 s	80 s	60 s	60 s
Product						
Product Name	Aluminium Ornament	Ceramic Ornaments	Glass Ornaments	Acrylic Name Plates	Photo Slate	Pen
Temperature	356 °F	356 °F	356 °F	356 °F	374 °F	428 °F
Time	50 s	250 s	240 s	60 s	480 s	420 s

FAQS:

Colors are lighter	The temperature is too low, the pressure is uneven, or the time is too short.
Printed picture is vague	The printing time is long, which causes the ink spread.
Colors are less bright	The pressure is too high or the temperature is too high.
Printed picture is partially vague	The heat is uneven.
Colors are different	The pressure is uneven or the surface of the printed item is uneven.
The paper sticks on the printed item	The temperature is too high or the coating of the item is in poor quality.

Note

- All the data above are our Combo Heat Press 3 in 1 only.
- All the data above are based on the test results of our sublimation blanks and for reference only. Please test your own products and find the proper parameters.
- Technical Help: support@pydlife.com

Safety Instructions

- Don't touch the heating platen and the silicone pad when the machine is heating up or is still very hot.
- This machine is not intended for use by children.

